



**NES Ltd.**  
**new energy systems**

12 Madara Blvd, 9700 Shumen, Bulgaria  
tel.: + 359 54 874 546 fax: + 359 54 874 556  
e-mail: [ftrade@sunsystem.bg](mailto:ftrade@sunsystem.bg) [www.sunsystem.bg](http://www.sunsystem.bg)



**PID controller model ST-81**  
**for WOOD-GASIFYING BOILER PyroBurn**

**MANUAL GUIDE**

Contents

I. Description.....	4
I.a. Basic Terms .....	5
II. Regular Functionality .....	6
II.a. Main Page .....	6
II.b. Changing the Central Heating and Hot Consumption Water Setpoint Temp.....	7
II.c. Firing Up .....	7
II.d. Manual mode .....	8
II.e. Central Heating Pump Activation .....	9
II.f. H.C.W. Pump Activation .....	10
II.g. Operation mode .....	11
II.g.1. House Heating Priority .....	11
II.g.2. H.C.W. Priority .....	11
II.g.3. Parallel Pumps .....	12
II.g.4. Summer Mode .....	12
II.h. Main Screen .....	13
II.i. Language .....	14
II.j. Factory Settings .....	15
II.k. Fitting Parameters .....	15
III. Protections .....	16
III.a. Thermal Protection.....	16
III.b. Automatic Sensor Check .....	16
III.c. Temperature Protection .....	17
III.d. Anti-Boil Protection .....	17
III.e. Monitoring the Flue gas outlet temperature.....	18
III.f. Fuse .....	18
IV. Maintenance. Technical parameters .....	18
V. Assembly .....	18

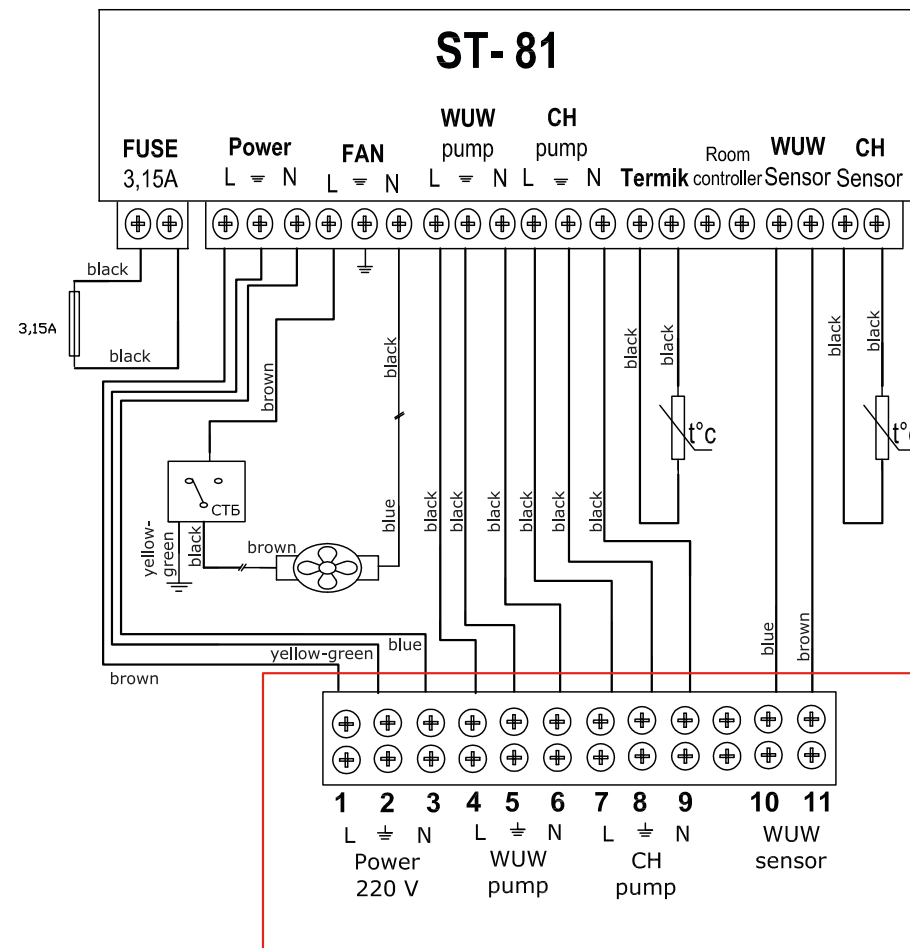

#### IV. MAintenance

Before and during the heating season, the **ST-81i** controller should be checked for condition of its cables. You should also check if the controller is properly mounted and clean it if dusty or dirty. It is advisable to measure grounding parameters for the motors (central heating pump, hot consumption water pump and fan)

#### PID controller model ST-81i Technical Specifications

1	Supply Voltage	V	230V/50Hz+/-10%
2	Power consumption	W	5
3	Ambient temperature	°C	10÷50
4	Circulation pump outlet load	A	0.5
5	Fan outlet load	A	0.6
6	Temperature measurement range	°C	0÷90
7	Measurement accuracy	°C	1
8	Temperature adjustment range	°C	45÷80
9	Sensor thermal resistance	°C	-25÷100
10	Fuse inset	A	3.15

#### V. Assembly

**ATTENTION:** all assembly works must only be carried out by qualified persons. During assembly, the device **must be** disconnected (make sure the power cord is unplugged)!

**ATTENTION:** improper cable connections may damage the regulator!

The regulator may not be operated in a closed-circuit central heating system. It is necessary to provide for safety valves, pressure valves and a surge tank in order to prevent water from boiling in the central heating system.



## ATTENTION!

### HIGH VOLTAGE!

Make sure the regulator is disconnected from the mains before working on the power supply (cable connections, device installation, etc.)!

All connection works must only be carried out by qualified electricians.

Before activating the controller, measure the motor resetting efficiency, check the boiler and inspect wire insulation.

## I. Description

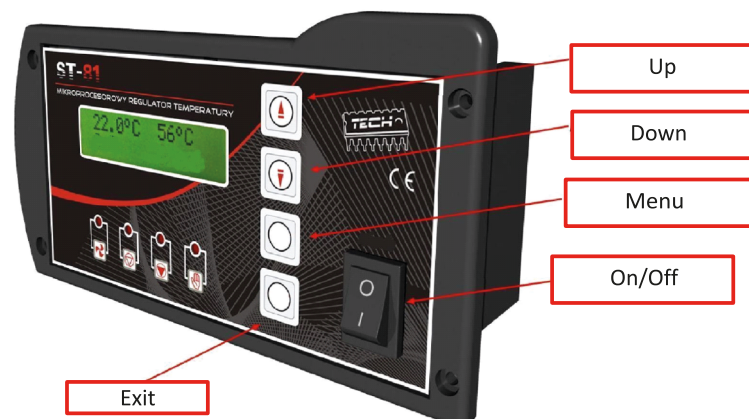

The **ST-81** temperature regulator is intended for use with central heating boilers. The regulator is used for controlling the central heating water circulation pump, hot consumption water pump and blow (fan).

The ST-81 is a PID-based controller **using a continuous signal**. In this type of controllers, the fan power is calculated based on boiler temperature and flue gas temperature measured at the boiler outlet. The fan runs continuously and its power depends directly on the measured boiler temperature and flue gas temperature as well as the difference between the two parameters and their setpoint values.

## III.c) Temperature Protection

The regulator features an additional protection in case the bimetal sensor is damaged. After the temperature exceeds 85°C, the alarm is sounded with the display showing the following message:

EN ALARM  
TEMPERATURE TOO

The current temperature is read from an electronic sensor and processed by the thermoregulator. When the alarm temperature is exceeded, the fan is shut off and both pumps begin to run in order to distribute hot consumption water throughout the system.

## III.d) Anti-Boil Protection

This protective function is used only with the **water heater priority** mode. For example, when the water heater setpoint temperature is 55°C and the boiler temperature rises to 67°C (5°C over the so-called *priority temperature*), the controller shuts off the fan. If the boiler temperature reaches 80°C, the C.H. pump will be activated. If the temperature continues to rise, the alarm will be activated at 85°C. Such condition may appear when the water heater or the pump is damaged or when the sensor has been improperly installed. However, if the temperature drops, the controller will activate the fan at 66°C and it will remain in the duty mode maintaining the priority temperature of 62°C.

## III.e) Fuse

The regulator has a network protection WT 3.15 A tube fuse. Higher current ratings may cause damage to the controller.

### III. Protections

In order to ensure a safe and faultless operation, the regulator has been provided with numerous protections. In the case of an alarm, an acoustic warning is sounded and the display shows a corresponding message.

Press the encoder to restore the controller to operation. In the case of the **C.H. Temperature Too High** alarm, wait until the temperature drops below the alarm value.

#### III.a) Thermal protection

The boiler is protected with an additional bimetal sensor (located at the boiler temperature sensor) that disables the fan when the temperature exceeds the critical value: 85°C. This is to prevent water from boiling in the system when the boiler has been overheated or the controller is damaged. When the protective function is enabled and the temperature drops to a safe value, the sensor will automatically restart the device and the alarm will be deactivated. If the sensor is damaged or overheated, the burner, fan and feeder are disabled.

#### III.b) Automatic Sensor Check

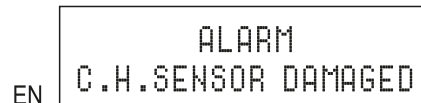

When the temperature sensor of the central heating or hot consumption water is damaged, an alarm is sounded with an additional indication shown in the display, e.g.: „**C.H. Sensor Damaged**“.

Blow is disabled and both pumps are activated simultaneously, regardless of the temperature.

If the central heating sensor is damaged, the alarm will remain active until the sensor is replaced. If the hot consumption water sensor is damaged, press **MENU** **to** deactivate the alarm and restore the single (house heating) pump mode. To be able to operate the boiler in all modes, it is necessary to replace the sensor.

#### I.a. Basic Terms

**Fire up.** The cycle begins when you activate the *fire up* function in the controller's menu and is active until the central heating boiler temperature reaches 40°C (the default *fire-up threshold*), on condition that the temperature does not drop below this value for 2 minutes (the default *fire-up time*). If these conditions are met, the regulator will switch to the *duty* mode and the *manual operation symbol* on the housing will be deactivated. If the controller fails to reach parameters required for entering into the *duty* mode within 30 minutes from activation of the *fire-up* function, the "Unable to fire up" message will appear on the display. In such a case, the fire-up cycle needs to be restarted.

**Duty** – once the *fire-up* cycle is finished, the controller enters the *duty cycle*. The duty cycle is the basic functionality of the regulator. The blow is controlled automatically using the zPID algorithm and the temperature is close to its setpoint value. In the user menu, *fan* item will appear in place of the *fire-up* function. The fan can be deactivated when needed (e.g. while feeding fuel). If the temperature rises unexpectedly by more than 5°C over the setpoint value, the so-called *Supervision Mode* is activated.

**Supervision Mode** – the mode is activated during the *Duty Cycle* if the temperature rises by more than 5°C over the setpoint value. In such case, the controller is switched from the PID control to manual settings (according to parameters entered in the Fitter's Menu) to reduce the temperature of the circulation water.

**Damping** – if boiler temperature drops by 2°C below the *fire-up threshold* and fails to rise above this value for 30 minutes (default *damping time*), the regulator will switch to the *damping mode*. While in this mode, the fan is deactivated and the display shows "Damping".

In case of voltage loss, the regulator ceases to operate. When power is restored, the controller returns to operation with previously set parameters using its built-in memory. Lack of voltage does not cause the stored parameters to be lost.

## II. Regulator Functionality

This chapter describes regulator functionality, how to change settings and navigate in the menu with the **encoder** (knob). Depending on the mode the boiler is currently in, the display will show boiler operational parameters. The given mode is selected by the user.

### II.a) Main Page

EN 

During normal operation, the **LCD** display shows the *Main Page* containing the following:

- **Boiler temperature** (to the left of the display).
- **Setpoint temperature** (to the right of the display).
- **Fan stop.** After manually stopping the fan while in the *duty mode*, the star symbol (\*) will appear in the top right corner.
- **Operation Mode.** In the bottom right corner, the corresponding letter of the operation mode is displayed. Depending on the operation mode, the corresponding symbol is displayed:
 

D – house heating,	B – water heater priority,
R – parallel pumps,	L – summer mode.

Pressing the encoder will move you to the main menu. The display shows two options of the menu. To select a different option, turn the encoder knob.

### II.j.) Factory Settings

EN 

EN 

EN 

The regulator has been pre-configured. However, it should be adjusted to your individual needs. It is possible to return to the factory settings at any time. By enabling the **Factory Settings**, all existing boiler settings will be replaced by settings made by the manufacturer. From then on, you can again set your own operating parameters for the boiler.

### II.k.) Fitting Parameters

Access to fitting parameters is disabled for the user. This special view contains advanced parameters accessible only by the manufacturer.

➤ H.C.W. Screen



This screen displays the current and setpoint H.C.W. temperatures. By turning the knob, you can change the setpoint H.C.W. temperature. After setting the appropriate value, confirm it by pressing the encoder knob.

II.i.) Language

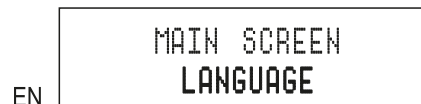

With this function, you can select the language of your controller.

II.b) Changing the central heating and hot consumption water setpoint temperature

In order to change the setpoint temperature of the central heating (while in "C.H. screen" main view), turn the encoder knob and (after setting a desired value) press it to confirm the change.

In order to change the setpoint temperature of the hot consumption water (while in "H.C.W. screen" main view), turn the encoder knob and (after setting a desired value) press it to confirm the change.

Chapter "Screen" describes methods of changing the main screen view.

II.b) Firing up

This function allows you to easily fire up the boiler. After igniting the boiler, you need to activate an automatic fire-up cycle. By selecting optimum parameters, the boiler uses the zPID function to smoothly switch to the duty mode. If the boiler reaches the *fire-up threshold* temperature, the *fan* item will appear instead of the *fire-up* function. From now on, the option will be used to activate/deactivate the fan. This setting allows you to temporarily deactivate the fan at any time, e.g. while feeding fuel.

If during the fire-up cycle the boiler does not reach 40°C **within 30 minutes**, (default parameters), the following warning message will appear on the display:

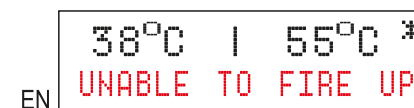

To restore the boiler to operation, switch off **the alarm** by pressing the **encoder** and restarting the **fire-up** procedure.

### II.d) Manual Mode

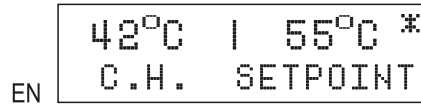

For your convenience, the regulator features a **manual mode module**. In this mode, each individual actuator is enabled and disabled independently of the other. In addition to the **Manual Mode** function, the **Blow Force** function has been provided.

To ensure durable operation of your boiler and its optimum performance mode, we recommend that the fan power value be always set to 4.

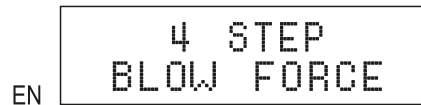

This function allows you to set the blow force of the fan while in the **Manual Mode**.

Pressing the **ENCODER** activates the fan. The fan will operate until the **ENCODER** is pressed again.

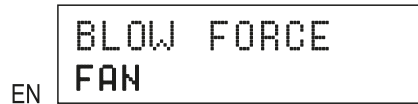

Press the **ENCODER** to enable / disable the central heating pump.



When the function is enabled, only the hot consumption water pump is running in order to heat water in the water heater. The pump is switched on above a predefined activation threshold (see the *pump activation temperature* function) and will run until the setpoint temperature has been reached. The pump will start again when the temperature drops below the set hysteresis. In the Summer Mode, only the setpoint temperature is set on the boiler that heats up water for the water heater (the temperature set for the boiler is also the temperature set for the water heater).  
*Summer Mode*, the letter L is displayed in the bottom right corner

### II.h.) Main Screen

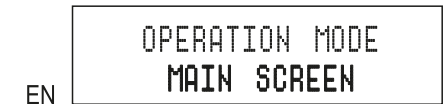

This function allows you to change the view of the main screen. The following views are available:

#### ➤ C.H. Screen

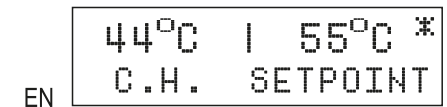
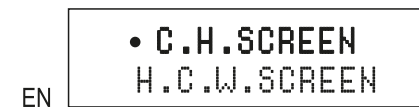

This screen displays the current and setpoint C.H. temperatures. By turning the knob, you can change the setpoint temperature. After setting the appropriate value, confirm it by pressing the encoder knob.



While in the *H.C.W. Priority* mode, the letter B is displayed in the bottom right corner of the main screen.

**ATTENTION:** The boiler should have non-return valves mounted on the central heating pump circuit and the hot consumption water pump circuit. A valve mounted on the hot consumption water pump will prevent hot consumption water from being drawn from the water heater.

### II.g.3.) Parallel Pumps



In this mode, the pumps start to run in parallel above the pump activation temperature (set by default to 35°C). These temperatures may, however, vary depending on user settings. This will cause irregular activation of the pumps. However, when both thresholds are exceeded, the pumps will operate simultaneously. The central heating pump runs continuously, while the hot consumption water pump stops after the setpoint temperature is reached in the water heater.

While in the *Parallel Pumps* mode, the letter R is displayed in the bottom right corner of the main screen.

**ATTENTION:** In this mode, a non-return valve should be fitted maintain different temperatures in the water heater and in the house. After activation of the parallel pumps function, three items appear on the display. Starting from the left, these are: Boiler Temperature (C.H.); Water Heater Temperature (H.C.W.) and Setpoint Temperature (C.H.).

### II.g.4.) Summer Mode



Press the **ENCODER** to enable / disable the (water heater) hot consumption water pump.



Press the **ENCODER** to enable / disable the alarm.

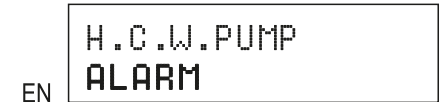

### II.e) Central Heating Pump Activation

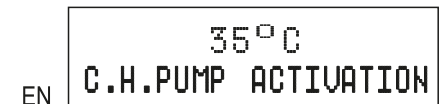
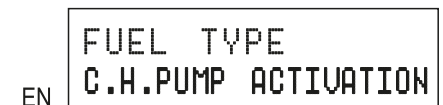
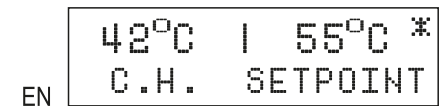

With this function, you can set the temperature that will activate the central heating pump (the temp. is measured on the boiler). The

pump will start if the setpoint temperature is exceeded. The pump will be deactivated when the boiler temperature drops below the activation temperature (minus hysteresis, e.g. 2°C). In this case, the pump will stop at boiler temperature of 33°C.

### II.f) H.C.W. Pump Activation

EN 42 C | 55°C \*  
C.H. SETPOINT

EN C.H.PUMP ACTIVATION  
H.C.W.PUMP ACTIVATION

EN 40°C  
H.C.W.PUMP ACTIVATION

With this function, you can set the temperature that will activate the hot consumption water pump (the temperature is measured on the boiler). Above the setpoint temperature (e.g. 40°C), the pump is activated and operates depending on the selected operation mode. The pump will be deactivated when the boiler temperature drops below the activation temperature (minus hysteresis, e.g. 3°C). In this case, the pump will stop at boiler temperature of 37°C.

### II.g) Operation mode - by selecting one of four operation modes

EN 42°C | 55°C \*  
C.H. SETPOINT

EN H.C.W.PUMP ACTIVATION  
OPERATION MODE

### II.g.1.) House Heating Priority

EN HOUSE HEATING \*  
H.C.W.PRIORITY

If you select this option, the regulator will switch to the house heating mode. The central heating pump starts to run above the pump activation temperature (set to 35°C by default). Below this temperature (minus central heating hysteresis), the pump is shut off. While in the *house heating* mode, the letter D is displayed in the bottom right corner of the main screen.

### II.g.2.) H.C.W.Priority

EN HOUSE HEATING  
H.C.W.PRIORITY \*

Activating the hot consumption water priority will cause the regulator to switch into the water heater priority mode. In this mode, the (hot consumption water) heater pump is activated until the set H.C.W. temperature is reached. Then, the H.C.W. pump is shut off and the C.H. pump is activated. The central heating pump will run until the water heater temperature drops below the setpoint value (and the H.C.W. hysteresis); then, the C.H. pump is shut off and the H.C.W. pump is activated.

In this mode, the fan is operated as long as the temperature is below 62°C to prevent the boiler from overheating.

The hot consumption water priority function consists in that the consumption water is heated up before heating up water in radiators.